



सत्यमेव जयते

MINISTRY OF RURAL DEVELOPMENT

RURAL ROAD MAINTENANCE TRAINING MODULES FOR CONTRACTORS

Module-6 HAND TOOLS, EQUIPMENT AND CONSTRUCTION MATERIALS





Ministry of Rural Development

RURAL ROAD MAINTENANCE TRAINING MODULES FOR CONTRACTORS

Module-6

Hand Tools, Equipment and
Construction Materials



This training module is produced through a collaborative effort between the International Labour Organization and the National Rural Road Development Agency under the technical assistance component of the World Bank supported Rural Roads Project-II of Pradhan Mantri Gram Sadak Yojana Project (PMGSY).

Contents:

- Hand tools used for road maintenance works
- Light equipment used in maintenance activities
- Soil technology
- Concrete

Learning Objective:

At the end of this Module you are expected:

- To be able to identify various hand tools and equipment used for road maintenance works
- To understand the importance and advantage of good quality hand tools
- To be able to identify the various soil types
- To be able to conduct field test to determine the suitability of the construction materials used in road works

Acknowledgement

The following publications were also used as reference materials:

- Building Rural Roads, Bjorn Johannessen, International labour Organization, ILO Regional Office for Asia and the Pacific, 2008
- A Practitioner's Guide to Rural Roads Improvement and Maintenance, International Labour Organization and Government of Ghana, 2014
- A Handbook for District Supervisors and Community Routine Maintenance Team for Routine Maintenance on District Roads, ILO/ UNDP, Indonesia, 2010

Foreword

Pradhan Mantri Gram Sadak Yojana (PMGSY), was launched in December, 2000 as a special intervention of the Government of India with the broad objective of ensuring sustainable poverty reduction. The scheme aims to provide good quality all-weather single connectivity to every eligible habitation. Rural roads are a state subject under the Constitution and as such are the basic responsibility of the states. However under the PMGSY, the construction of good quality and well-engineered roads are fully funded by the central government. Maintenance of these roads is the responsibility of the states. The year 2013 saw the launch of PMGSY-II with the objectives of consolidating the existing rural road network and upgrading existing rural roads that provide connectivity to rural growth centres. PMGSY-II envisages sharing of construction costs between the Centre and the states with maintenance costs continuing to be funded fully by the states.

Over the last 14 years, the PMGSY has carved out a place for itself as a programme characterised by creation of good quality assets, effective management and technical proficiency by the National Rural Road Development Agency (NRRDA), along with capable state road agencies. For implementation and operations, the involved agencies have been supported with detailed documentation in the form of programme guidelines, an operations manual, standard bidding documents, specifications, a standard data book, a procurement and contracts management manual and the Quality Assurance Hand Book with support from the Indian Roads Congress. These documents have also contributed significantly towards effective implementation of PMGSY and even for mainstreaming good practices in other rural roads programmes being executed by the states from their own resources.

An area of concern has been lack of regular maintenance as per the “Programme Guidelines”. However, in recent years, there has been increased awareness and commitment to maintenance by the states. The tempo needs to be sustained and further accelerated.

Under the technical assistance component of the World Bank supported Rural Roads Project-II, the International Labour Organization (ILO), in collaboration with NRRDA has prepared a manual “Managing Maintenance of Rural Roads in India”. This initiated the execution of maintenance works and the development of these training modules for engineers and contractors associated with rural road maintenance works. To strengthen such activities in the participating states of RRP-II, a series of training of trainers workshops were arranged at national and state level based on the course material developed.

The training modules broadly cover the principles for maintenance management of rural roads, planning and execution of common maintenance interventions to ensure reliable transport services and safety to users and the local communities served by the rural roads, and arrangements for monitoring the performance of contractors engaged for the task.

I would like to acknowledge the support of all those associated with the development of these training modules, especially the ILO and its technical assistance team, Mr. Htun Hlaing, Mr. Bjorn Johannessen and the project's Rural Roads Maintenance Engineers. I would also place on record the valuable suggestions of my colleagues Ms. Manju Rajpal, IAS, (ex Director – RC), Mr. R. Basavaraja, Director NRRDA, Mr. S. S. Bhatia, Deputy Director, NRRDA, Mr. A. K. Sharma, Consultant World Bank and senior engineers as well as secretaries from State Governments in bringing the document to its present shape.

I sincerely believe, the training modules would be found useful for the states in their efforts to secure adequate maintenance of all rural roads, not merely the PMGSY roads and improve maintenance practices so that benefits of access continue to remain available for our rural people on a sustainable basis.

(Rajesh Bhushan, IAS)
JS (RC) & DG, NRRDA
Ministry of Rural Development
Government of India

October, 2015



Introduction to Training Modules

The purpose of this training manual is to provide technical management staff and contractors with appropriate guidelines for the effective management of road maintenance works. The training modules are based on the manual “Managing Maintenance of Rural Roads in India”. These modules broadly cover the principles for maintenance management of rural roads, planning and execution of common maintenance interventions to ensure reliable transport services and safety to users and the local communities served by the rural roads. The arrangements for monitoring the performance of contractors engaged for the task are also covered in these modules.

This manual is broken down into the following categories composed of different modules:

Module 1: INTRODUCTION

Module 2: TECHNICAL CONSIDERATIONS AND IMPLEMENTATION ARRANGEMENTS

Module 3: CONSTRUCTION MEASUREMENT AND BASIC CALCULATIONS

Module 4: PLANNING AND WORK ORGANISATION

Module 5: APPROPRIATE SETTING OUT TECHNIQUES

Module 6: HAND TOOLS, EQUIPMENT & CONSTRUCTION MATERIALS

Module 7: ROUTINE MAINTENANCE WORK METHODS

Module 8: OCCUPATIONAL HEALTH & SAFETY, ENVIRONMENTAL ISSUES AND DECENT WORK

Module 9: COSTING AND TENDERING

The trainer may decide to conduct a full course consisting of all the nine modules or may selectively conduct specific modules depending on the needs of the target group.

As a general advice the trainer should:

- **Encourage active participation**

There is sometimes a tendency of the trainer to act like a teacher in school and to read or lecture directly from the course material. This behaviour should be avoided. Trainees remember information better if they participate actively in discussions and if there is a free exchange of views and of questions between everyone participating in the course.

- **Guiding the discussion**

There are times during a discussion when everyone wants to speak at the same time. When such situations arise, the trainer should insist that the group listen to one person at the time. If one speaker hijacks the floor too long, the trainer needs to interrupt, pointing out that other participants may also want to speak.

- **Listen attentively**

Equal attention should be paid to each speaker. Listen attentively and let the speaker understand that ideas and opinions expressed are both interesting and relevant. It is sometimes useful to take a brief note of participants' suggestions while they are speaking, noting them down on a flipchart or blackboard. A summary of these notes may prove useful for later discussions.

- **Emphasise important points**

Each time the participants make an important point or expresses an interesting opinion, the trainer should draw the group's attention to it by repeating the idea in simple terms which are understood by the majority of the trainees.

- **Preparing the sessions**

When trainees only listen to a description of how a particular job should be done, they are likely to forget what they heard. If however, they actually carry out the task concerned, they will remember how to do it. For this reason, every effort should be made to include as many practical exercises and demonstrations as possible, be they carried out on the worksite or in the training room. Practical sessions should always be carefully planned in advance.

- **Recapping**

A discussion is more than just a conversation. A subject is discussed with an aim in mind. It may occasionally be worthwhile recapping the topic considered and recalling the aim of the discussion by intervening from time to time to give a brief summary of the main points dealt with so far.

- **Questioning**

An important role of the trainer is to ensure that the atmosphere during training is sufficiently relaxed to allow participants to feel at ease to speak freely. Questions set by the trainer should not be regarded by the trainees as tests. Often there is no strict "right or wrong" answer to a question, except for mathematics. Questions should simply give your trainees the opportunity to put forward their individual points of view.

Table of Contents

6. HAND TOOLS, EQUIPMENT AND CONSTRUCTION MATERIALS	1
6.A HAND TOOLS FOR ROAD MAINTENANCE WORKS	1
6.1 Importance of Quality Handtools	1
6.2 Common Hand Tools for Road Maintenance Works	3
6.2.1 <i>Shovel and spade</i>	4
6.2.2 <i>Pick and mattock</i>	4
6.2.3 <i>Hoe</i>	5
6.2.4 <i>Rake and spreader</i>	5
6.2.5 <i>Grass cutter or slasher</i>	6
6.2.6 <i>Hand rammer</i>	6
6.2.7 <i>Wheelbarrow</i>	7
6.B LIGHT EQUIPMENT USED IN RURAL ROAD MAINTENANCE WORKS	9
6.C CONSTRUCTION MATERIAL FOR RURAL ROAD MAINTENANCE WORKS	11
6.3 Definition of Soil	11
6.4 Identifying Soil Types	11
6.5 Soil Identification Tests	12
6.6 Field Tests for Identification of Soils	12
6.6.1 <i>Touch and feel test</i>	12
6.6.2 <i>Identifying silt and clay</i>	13
6.6.3 <i>Field compaction test</i>	16
6.6.4 <i>Moisture content</i>	17
6.6.5 <i>Hand moisture content test in the field</i>	18
6.6.6 <i>Compaction</i>	19
6.7 Cement	21
6.7.1 <i>Storage of Cement</i>	22
6.8 Aggregate for Concrete	23
6.8.1 <i>Storage of Aggregate</i>	24
6.9 Types of Concrete	24
6.10 Batching Concrete	25
6.11 Concrete Production	27
6.11.1 <i>Transporting and Placing of Concrete</i>	28
6.11.2 <i>Curing Concrete</i>	30
6.12 Reinforcing Concrete	31
6.13 Testing Concrete	32
6.14 Bitumen	36
6.14.1 <i>Requirements of Bitumen</i>	37



Hand Tools, Equipment and Construction Materials

6.A HAND TOOLS FOR ROAD MAINTENANCE WORKS

Many road maintenance activities are carried out by labourers using basic hand tools. Labour may not have experience with some hand tools used in road works and will therefore be unwilling to use them, rather preferring traditional methods, or may use them inefficiently. It is therefore essential that the supervisor understand the importance of good, well-maintained tools and instructs and trains workers in their use.

6.1 Importance of Quality Handtools

Most cost-conscious contractor tends to get maximum use from worn out tools and then to seek out the cheapest replacements when the tool eventually is damaged. However, research has showed that quality tools maintained in good condition more than justify their purchase cost and timely replacement increases productivity. (See Table 1)

Table 1: Comparison of cheap poorly maintained with good quality and well maintained hand tools

Poor Quality Hand Tools	Good Quality Hand Tools
Breaks easily	Strong
Wear out quickly	Long lasting
Reduce output of worker	Increase output of worker
Frustrate the worker	Satisfy the worker
More labour cost for contractor resulting in decreased profit	Less labour cost for contractor resulting in increased profit
Frequent replacement cost to contractor resulting in limited profit	Less frequent replacement cost resulting in increased profit

Neglect of tool quality and supply are likely to result in the following major dis-benefits to both the worker and his/her employer (Contractor):

- a. Increased worker fatigue
- b. Low worker efficiency
- c. Low productivity
- d. Poor quality work

- e. Increased idle time
- f. Increased worker time input
- g. Reduced worker earnings
- h. Disruption to work schedule
- i. Reduced flexibility associated with the task-work and piecework systems in accommodating other worker obligations and interests
- j. Delay in project completion

Money spent on replacing worn out tools with good quality tools and keeping them in good condition with new handles and regular sharpening will more than repay the cost through longer life, increased productivity and a motivated workforce.

Every hand tool used on road maintenance works has an economic life and the contractors need to know that if the workers' productivity is to be maintained. Table 2 shows economic life of hand tools used on road maintenance works. It should be noted that the quality of tools will affect the economic life of the tools. Therefore it is important for contractors to keep record of the tools performance and update the table for their future reference in costing works.

Table 2: *Indicative economic life of hand tools used in maintenance works*









Hand Tools & Protective Gear	Economic life (months)	Hand Tools & Protective Gear	Economic life (months)
3mm diameter nylon rope 200m	6	Crow bar, chisel and point	24
5lb hammer	12	Spare axe handle	12
Sledge hammer 14lb	24	Spare Handle Hoes	12
Tape measure 30m	12	Spare Handle Mattocks	12
Tape measure 5m	12	Spare Handle Pick axes	12
Boning rod set	24	Spirit level (4 feet)	12
Profile boards	12	Square	12
Ranging rods	12	Mason's trowel	24
Line level	24	Mortar pans (head-pan)	6
Earth rammer 14lb	24	Steel floats	12
Heavy duty rake (spreader)	12	Bow saw 26"	12
Hoe	12	Claw hammer 1.5lb	24
Shovel, round nose	12	Water drum (200 litres) (Plastic)	36

Spade	12	Watering can	12
Slasher grass	6	Wooden floats	12
Axes (short handle)	12	Camber template (wooden)	12
Jerricans or Buckets	6	Ditch template (wooden)	12
Pickaxe	12	Slope/ditching template (wooden)	12
Mattock 4.5lb	12	Gloves	6
Cutlass	6	Gumboots	12
Rip saw	12	Overalls	12
Wheelbarrows	24	Safety goggles	12

6.2 Common Hand Tools for Road Maintenance Works

The most common hand tools used in rural road maintenance works are shown below. The number of tools required will depend on the work load and the maintenance activity.

Table 3: *Hand tools required for road maintenance works*

				
wheelbarrow	Grass cutter	Bush knife	Handsaw	Axe
				
Crowbar	Shovel	Shovel with long handle	Hoe	Pickaxe
				
Rake	Broom/brush	Hand rammer	Watering can	Bucket
				
Basket	Hammer	Pegs and string	Mason's tools	Tool sharpeners
				
Road safety signs	Gloves	Gum boots	5m tape-measure	50m tape-measure

6.2.1 Shovel and spade

A shovel and a spade both consist of a metal blade and a wooden handle. A shovel is usually pressed from sheet steel and has a lighter construction, concave blade, sometimes with raised sides, designed to retain loose material.

A spade has a heavy-duty, forged flat blade. A spade blade usually has a rolled over top edge, to allow the worker to apply his weight for better penetration.

Figure 1: Illustration of Shovel and Spade

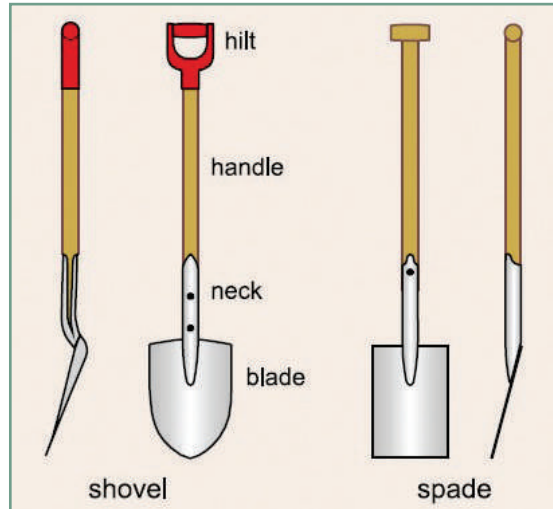

Shovels and spades are more effective if the edges are sharp. This can be done by using a file to sharpen them. Handles should be checked for tightness and replaced, as necessary. Avoid replacement handles cut from bush materials on site. A good shovel or spade will wear out with the edges still remaining sharp and once it gets very worn-out it must be replaced. Sometimes chips or broken edges may have to be removed on the grindstone.

6.2.2 Pick and mattock

Picks are forged tools, with one tip pointed, the other chisel shaped and about 40mm wide, both tips specially hardened and polished.

A pick is used to loosen successive layers of hard material, such as found in a gravel pit, using considerable force and leverage exerted by a full swing on its small tip.

The mattock is a forged tool, with two cutting edges, one horizontal and one vertical, both edges hardened and polished.

Both picks and mattocks are fitted with properly seasoned hardwood handle. Oval handles are best, as they are easier to grip than round handles and also make for a better fit between the blade and the handle. (see Figure 2)

Figure 2: Illustration of Pick and Mattock

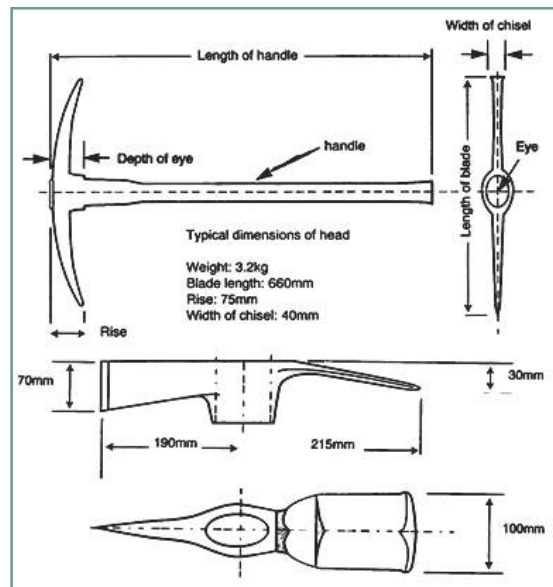

The mattock combines some of the abilities of the pick and is used to break and excavate harder soils, where the spade would be inadequate. The maintenance of picks and mattocks are limited to checking the tip for sharpness and ensuring the handle remains a firm fit.

6.2.3 Hoe

A hoe consists of a metal blade and a wooden handle. The best hoe blades are of one-piece forged construction and these may last for up to three years. The cutting edge should be at least 20cm wide. The handle should be well-seasoned hardwood, about 70cm long. Oval handles are best, as they are easier to grip than round handles and also make for a better fit between the blade and the handle.

Figure 3: Illustration of hoe maintenance

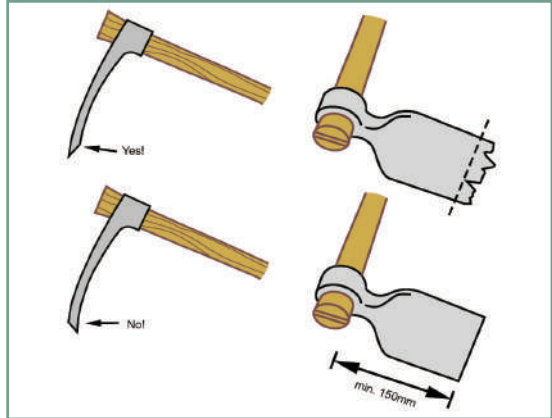

The ordinary hoe is a common agricultural tool, but the hoe used for road works even though similar in appearance should be very strong and able to withstand the hard task that it is used for. It is a digging tool, combining the functions of a pick and a spade in one tool. In construction it is suitable for loosening of soft soil, shaping of slopes, breaking out large lumps of cohesive soils and grubbing.

Hoes should be sharpened regularly, - daily with a file on site and periodically on a grindstone in the workshop. For best results, only the edge closest to the handle (the inner part of the edge) should be sharpened, as shown in Figure 3. Chipped and broken cutting edges should be ground out and re-sharpened. When the length of the blade is less than 150mm, the hoe is no longer efficient for digging.

6.2.4 Rake and spreader

Rakes can be used for raking out cut grass and other vegetation. Commercially available rakes are generally too light for use as spreaders on the construction site. A suitable spreader can be made locally from steel plate (+/-5mm) to the approximate dimensions. A suitable socket cut from steel tube (or G.I. water pipe) is welded and braced to the blade as shown, to secure a 150cm long hardwood round handle. Poor quality welds are a frequent source of recurrent breakage.

Figure 4: Illustration of Rake and Spreader

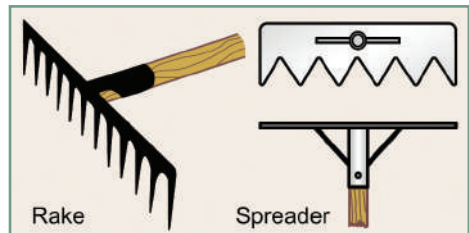

A spreader should weigh 3 to 4 kg, to provide sufficient downward gripping force on the loose material.

The spreader is used to spread fill material such as to construct a camber or gravel for the surface-course on the road.

Maintenance is limited to checking the security of the handle and braces.

6.2.5 Grass cutter or slasher

The grass cutter or slasher, is a simple and inexpensive tool used for trimming light grass. It consists of a metal strip 50mm wide and 3mm thick. The bottom 20cm is cranked and sharpened on both sides. The slasher therefore cuts when swinging it in both directions, and can be held alternately with both hands. The top end of the blade is fitted with a wooden handle, riveted on to the metal strip.

Routine maintenance workers commonly use a grass cutter for clearing the vegetation on road shoulders and in side drains. It is also used when initially clearing the road reserve. It is an efficient tool for light and moderately dense grass or bush. Thicker and denser grass or bush would normally require a stronger cutting tool such as a bush knife.

Figure 5: Illustration of a grass cutter or slasher

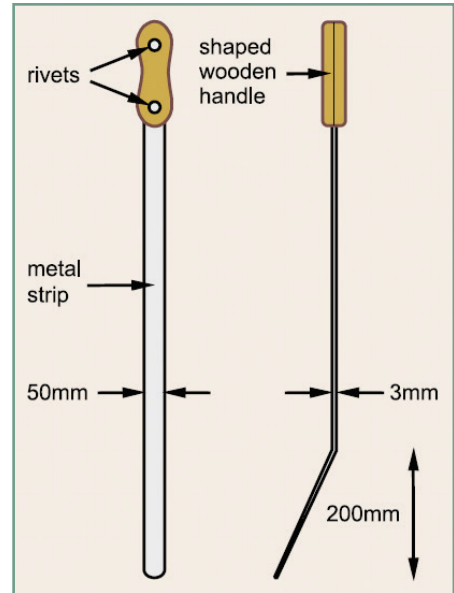

Maintenance is limited to sharpening the blade and securing the handle.

6.2.6 Hand rammer

Hand rammer is used for compacting soil. It consists of a flat-bottomed weight mounted on a vertical handle. Its effectiveness depends on its weight and the area of the base. In compaction terms, the heavier the better, but in practical terms, it must be within the abilities of the worker. The ideal compromise is a weight of 8 to 10 kg and a base diameter of between 100 to 150 mm. The handles are straight and about 60mm diameter. They can be made from wood handle or galvanized iron pipe. They must be long enough to permit the worker to stand straight. Figure 6 shows the design of one type of rammer commonly available in India.

Rammers are used to compact soil in smaller surface areas and restricted areas inaccessible to mechanical vibratory rollers, such as the backfill around culverts, filling potholes etc. The fill should be severely restricted to a loose

depth of 100mm, if the hand rammer is to compact adequately. The rammer is used by lifting and dropping on the area to be compacted.

Maintenance is limited to replacement of the wooden handle, as required. Wooden handles can be secured by fitting a wedge loosely into the base of the handle and then driving the handle into the socket on the rammer, so driving the wedge into and expanding the handle.

6.2.7 Wheelbarrow

The contractor must pay particular concern to the selection of good quality and well-designed wheelbarrows both to increase productivity and to ensure a long working life. A good wheelbarrow has its center of gravity well forward over the wheel to reduce the load supported by the user through the handles. It is also stable and easy to tip. The wheelbarrow is used for transporting soil for fill material and gravel for distances up to 200m.

All bolts should be regularly checked and tightened and axles greased. Well-inflated tyres considerably reduce the rolling resistance and will show great productivity gains, particularly in soft ground.

The most common hand tools and the recommended activities used for road maintenance works is summarized in Table 4.

Site productivity and worker motivation undoubtedly increase with good quality tools. However, all tools will deteriorate from the first day of use. It is therefore important to adopt a routine of daily maintenance of all hand tools. The expense of employing a 'tools mechanic' and supplying him with the proper equipment to maintain tools will be amply repaid in both daily site output and prolonged tool life. The essential tools include a portable vice, a grinding wheel, various steel files, spanners, grease, a hacksaw and blades, wedges and spare handles and wheelbarrow inner tubes. Each supervisor should also carry a steel file and encourage workers to use it to sharpen their own tools.

Figure 6: Illustration of a Hand Rammer

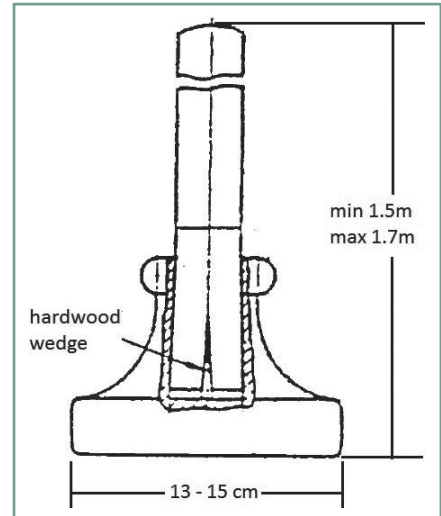

Figure 7: Illustration of a typical wheelbarrow

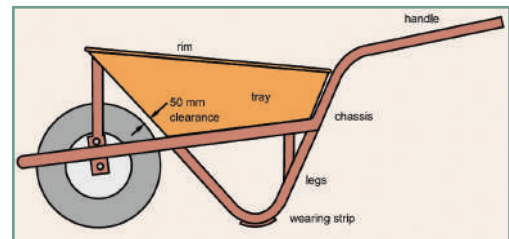

Table 4: *Common tools used for road maintenance works*

Operation	Activity	Recommended Hand Tools
Clearing	bush clearing	bush knife, axe, cutlass, bow saw
	grass cutting	grass cutter (slasher), rake
	tree and stump removal	axe, bow saw, ropes, pick axe, mattock, crowbar
	grubbing	hoe, shovel, spade, rake, basket, wheel barrow
	boulder removal	crowbar, sledge hammer, chisel and wedges
Earthworks	excavation	hoe, mattock, pick axe, spade
	hauling	baskets, head pans, wheel barrow, shovel
	spreading	spreader, hoe, rake, shovel
	compaction	hand rammer, watering can
Gravelling	excavation	mattock, pick axe, spade
	spreading	spreader, hoe, rake, shovel
Setting Out	road works	line level and fish line, ranging rods and profile boards, boning rods, measuring tapes, axe, hammer, chisel, string, pegs

6.B LIGHT EQUIPMENT USED IN RURAL ROAD MAINTENANCE WORKS

All off-carriageway routine maintenance works are carried out by labour using hand tools. However for selected situation and for on-carriage way maintenance works, some light appropriate equipment will be required to supplement the work where labour alone cannot achieve the required specification. Some of these equipment are listed in Table 5 below.

Table 5: Common equipment used on rural road maintenance works

EQUIPMENT	USE
<p>Tipper and Flat-bed lorries</p> 	<ul style="list-style-type: none"> • For hauling distances more than 10km. • Flat-bed lorries or tippers are usually a better alternative than tractor-trailer combinations for long hauls. The disadvantage is that they stand idle while being loaded in the quarry and gravel has to be thrown to a higher height than for trailers. • Quarries should be well organized and set up so that the loading is more suitable for labourers.
<p>Tractor – Trailer combination</p> 	<ul style="list-style-type: none"> • Transporting of labour to and from site. • Transporting of materials to and on site. • Transporting of gravel from gravel pit to construction front with hauling less than 10km. • Trailers are towed by a tractor for transporting gravel, materials and personnel. Each tractor should have two trailers so that the tractor can be optimally utilised, e.g. one trailer is loaded in the quarry while the other is hauled to site.
<p>Pedestrian Roller</p> 	<ul style="list-style-type: none"> • Pedestrian vibrating rollers are often used on labour based road work and maintenance work to compact the formation, gravelling layer as well as pothole patching works.
<p>Water bowser</p> 	<ul style="list-style-type: none"> • Watering of fill material may be required to have optimum moisture content for effective compaction. • Water supply for other site activities. • Bowsers should be provided with a spraying bar to ensure uniform spraying is possible. If possible they should be provided with a water pump.



6.C CONSTRUCTION MATERIAL FOR RURAL ROAD MAINTENANCE WORKS

6.3 Definition of Soil

Soil is the substance on the surface of the earth in which plants grow. Soil is a material that can be used as 'construction material' for building roads, dams and bricks. It is the material lying on the earth's surface. It consists of a mixture of solid particles of various sizes and spaces (voids) filled with either air or water.

Soil is the main building material used in rural roads foundation. There are many types of soil and they vary considerably in their suitability for used in construction works. Complete testing of soil can only be carried out by soil technicians working with soil samples in a laboratory. Nevertheless, there will often be times when the soils technician is not available and one must decide if a soil can be used in road work. It is therefore important to be able to recognize different kinds of soil and know if a particular type is suitable or unsuitable for use in road works. To do this, it is necessary to know how to carry out some simple tests to help to identify the type of soil and judge its suitability for use in the construction works.

6.4 Identifying Soil Types

The first step in identifying the type of soil is to know the size of the grains, or particles, which make up the common soil types as shown in Table 6.

Table 6: *Common soil type and classification by particle size*

Major class	Sub-class	Range of particle size (mm)	Remark
Boulders	–	Larger than 200	
Cobbles	–	200–60	
Gravels	Coarse gravel	60–20	Stones of between 2mm and 60mm in size. Non-cohesive even when wet.
	Medium gravel	20–6	
	Fine gravel	6–2	
Sands	Coarse sand	2.0–0.6	A fine to coarse gritty soil, with grains between 0.06mm and 2.00mm in size. Non-cohesive when dry, but slightly cohesive when wet.
	Medium sand	0.6–0.2	
	Fine sand	0.20–0.06	
Silts	Coarse silt	0.06–0.02	A gritty, slightly cohesive soil with very small particles between 0.002mm and 0.06mm in size. Powdery when dry, slightly cohesive when wet.
	Medium silt	0.020–0.006	
	Fine silt	0.006–0.002	
Clay	-	Less than 0.002	A fine, cohesive soil, with very small particles less than 0.002mm in size. Sticky and soft when wet, hard, crumbly lumps when dry.

Most soils contain a mixture of several different particle sizes, but some soils may contain material of nearly one size. The mixture of the different particle sizes is called the grading of the soil:

Well Graded Soil contains a good mixture of a wide range of sizes. (Figure 8)

Figure 8: *Well graded soil*

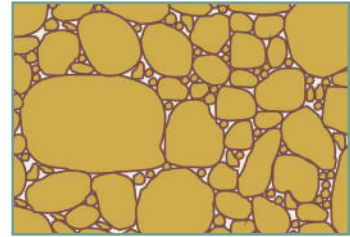

Uniformly Graded Soil contains only a small range of sizes, mainly concentrated in one particular size, with grains of other sizes lacking.

Poorly Graded Soil contains too much material of one or two sizes only and not enough of all the other sizes. (Figure 9)

Figure 9: *Poor graded soil*

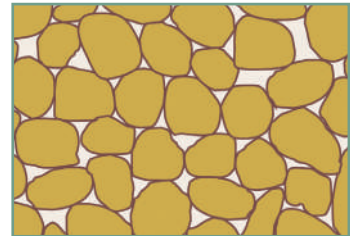

It should also be noted the presence of Organic Materials in the soil. It is likely to be found on layers closest to the surface. Large pieces of organic materials such as dead roots and leaves can easily be detected. When the soil smells of plants it is likely to contain considerable amount of organic materials. They are normally not suitable for road works except for use as a layer for planting grass for erosion protection.

6.5 Soil Identification Tests

Detailed soil identification test should be conducted in the laboratory by qualified Soil Technician. If there is any doubt, a qualified Soils Engineer must be consulted.

6.6 Field Tests for Identification of Soils

The following simple test can be used in the field to guide the supervisors during construction that the correct type of soil and moisture content is used.

6.6.1 Touch and feel test

First taking a sample of the soil sample and mould it in the hand. The following observations can be made through the visual inspection as well as through the feel of it.

- Larger particles are clearly visible indicating the presence of small stones.
- Smaller sand particles can easily be detected by touch and by rubbing the soil between two fingers.

- A gritty feel of the sample indicates the presence of sand and gravel.
- Fine sand does not stain the fingers, as opposed to soils with a certain clay content which leaves a stain.
- If, after drying, the sample retains its shape, it can be assumed that the soil contains a significant amount of clay.

A flat thick piece can also be made from a moist sample. By trying to penetrate it with a pencil will indicate the contents of clay.

- If the pencil penetrates easily, the material contains too much binder or clayey material.
- If it is difficult to penetrate, there is a good mixture of fine and course materials that interlock well.

6.6.2 Identifying silt and clay

The following tests are a guide to identifying the clay and silt proportions within the fines of the soil:

- Dry silt lumps will dissolve easily into a powder between your fingers.
- Dry silt will absorb water.
- Wet silt will crumble when squeezed between your fingers.
- Moist silt will only roll into short threads and then crumble and break.
- Dry lumps of clay are hard to break into smaller lumps.
- Clay has a smooth, glossy surface.
- Wet clay can be squeezed between your fingers.
- Wet clay will stain your hands while wet silt will not stain your finger.
- Moist clay can be rolled into a long ribbon between your palms.

VIBRATION TEST

This test identifies the particle size distribution.

Place a dry sample on a piece of board (Figure 10). While lifting one end of the board tap it lightly with a pencil. The finer material will move up the slope or remain in place, while the coarser, heavier material will move downwards.

Figure 10: *Vibration test*

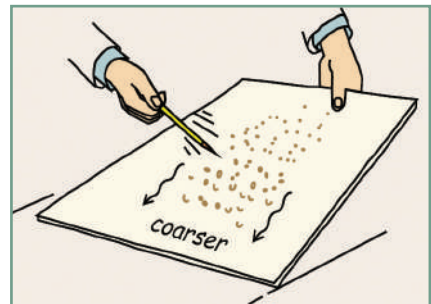

- If there are a lot of different sizes evenly spaced between the smallest and largest, the sample is well-graded and will compact well.
- If only a few sizes can be seen, then it is single size or poorly graded and will be difficult to compact.

COHESION TEST

This test will indicate the approximate clay or silt content in a soil sample and help us estimate the proportions of fine, medium and coarse particles.

Wet a handful of soil and try to shape it into a ball.

- If the material will not shape into a ball, then it contains only coarse sand and gravel.
- If a ball forms, but it crumbles away easily, then it contains fine sand.
- If a ball can be formed and shaped easily and keeps its shape and the material stains your hands, then the sample is clay or clayey silt.

PLASTICITY TEST

These tests help decide if a gravel sample is suitable for use as either a surface-course or as a concrete aggregate, however, we must also decide if the fines are clay or silt. As we have learned, clay is essential in a surface-course to bind the gravel together into a cohesive, strong and durable surface. Clay has a high plasticity, that is, the ability to expand and shrink without crumbling into powder. Silt, on the other hand, has low plasticity and is not cohesive and will become powdery and crumble when dry and will not bind gravel. Further tests are therefore necessary to decide if the fines are silt or clay. Table 7 below shows tests, which measure the plasticity of a soil sample.

Table 7: *Plasticity test*

Drying

Leave the sample jar in the sun until almost all the water has evaporated but the material is still slightly moist. Remove the fines carefully from the top of the sample with a spoon.

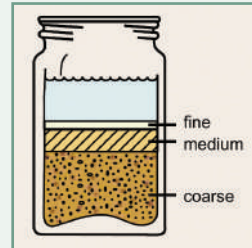

Moulding Test

Try to form ribbons of threads with your hand on a smooth table or board. The material must still be moist for you to be able to do this.

- If the fines are mainly silt, the ribbons will crumble, or will be very short, and the soil will not stain your hands. This indicates a low plasticity. Not suitable as gravel material for surfacing.
- If the fines are mainly clay, you will be able to form ribbons and the soil will stain your hands. This indicates a high plasticity. Suitable as gravel material for surfacing.

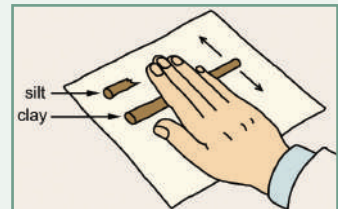

Dry Strength Test

In this test a sample is taken, which has been properly dried. An attempt is then made to break it using the thumb and forefinger of both hands. If it is possible to break it, an attempt should be made to crumble the sample between two fingers.



- If the sample can hardly be broken and cannot be crushed into powder form by finger pressure, it will consist of a highly plastic soil.
- If the sample can be broken and powders more easily, the material is less plastic.
- Soils with no plasticity have very little dry strength and crumble easily when picked up and applying the slightest pressure.

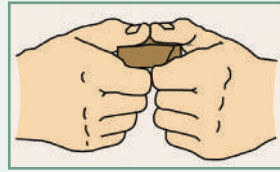

Drying Test

Make sure that the fines are still moist. Fill the material evenly into a matchbox and let it dry.

- If it is silt it will not crack and shrink but will tend to crumble when touched.
- If it is clay it will crack and shrink.

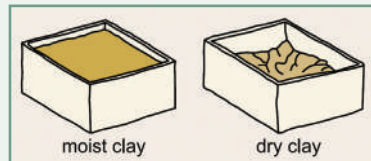

6.6.3 Field compaction test

In the field, before any proper lab test is conducted the following can be used as a rough guide to test if proper compaction is achieved.

- Using a hand rammer, hit hard by ramming the surface that was compacted earlier.
- If the rammer does not make any depression mark on the surface, it might indicate that it is well compacted.
- If the rammer makes depression marks, more compaction is needed.

Field Density Test (Sand Replace Test)

Compaction in the field should take place slightly below optimum moisture content as determined in the laboratory during compaction tests. This is necessary in order to take advantage of the increases in performance developed in modern compaction equipment.

Conventional performance-based specifications require the compaction of each of the various layers forming the road or earth embankment layer to be

Figure 11: Sand Replacement Apparatus - pouring cone, tray, calibrating container



verified following construction. Field density testing is necessary to confirm whether or not the desired density has been achieved. On larger projects with adequate levels of supervision this is usually accomplished using sand replacement apparatus (Figure 11) or nuclear density test equipment.

The sand replacement test consists of excavating a small hole 100mm or 200mm in diameter to the full depth of the layer to be tested. All of the excavated material is collected and weighed and a sample is then reserved for determination of the in-situ moisture content.

A pre-weighed sample of dry sand is placed in the sand pouring cone. The excavated void is filled with dry sand from the sand pouring cone. The weight of sand remaining in the cone is determined. The weight of sand required to fill the excavated void is then calculated from the difference in weight between the pre-weighed sample and the weight of the sample retained in the sand pouring cone.

The calibrating container is used to ascertain the density of the dry sand. The volume of the excavated void is calculated from the density of the dry sand and the weight of dry sand taken to fill it. The in-situ wet density of the test material is calculated from the volume of the void and the weight of material excavated. The field dry density can then be calculated after determination of the in-situ moisture content. The compaction achieved is expressed as a percentage of the field dry density divided by the maximum dry density.

6.6.4 *Moisture content*

Three things present in all soils are the soil particles, water and air.

The presence of air spaces (voids) is undesirable, as they allow water to circulate freely between the solid particles and so reduces the stability and strength of the soil.

Too much water reduces the soil strength, as it lubricates the solid particles and lets them slide and move easily under load. However, a certain amount of water is desirable when compacting, as it makes it easier for the solid particles to slide into the voids and produce a dense, strong mass. Even clay soils need a certain amount of water for compaction to avoid from crumbling and shrinking.

There is a correct proportion of water to make each soil type stronger and denser and this amount normally varies between about 8% and 20% of the total volume, provides a lubricating effect between the soil particles and thereby facilitates the compaction. Having a certain amount of water in the soils during compaction has a significant effect in terms of achieving the required pavement strength and stability.

- Too little moisture and the particles will not slide into the smallest possible space, because the material becomes brittle and flaky.
- Too much moisture will fill the voids and prevent the soil particles packing closer together.

- The amount of water in a soil sample is called the 'moisture content' and is expressed as percentage. The ideal amount of water to achieve maximum compaction is called the 'optimum moisture content'. The illustration in Figure 12 and Figure 13 shows the effect of water in achieving correct compaction.

Figure 12: *Illustration of effect of water in achieving proper compaction*

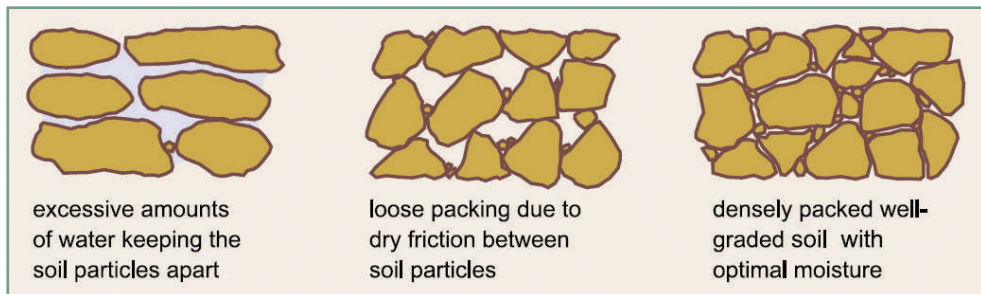
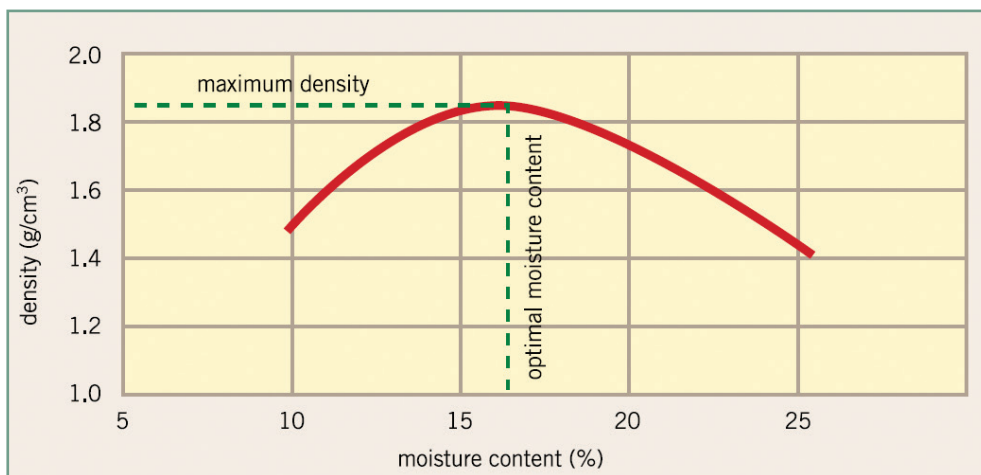

Figure 13: *Diagram indicating optimum moisture content*



The soil technician can test in the laboratory to decide what the optimum moisture content for any soil is, but he/she is not often on site, so it is important to learn to judge the moisture content on site. On the construction site, the best way to check if the material is within the required moisture content range is by performing a simple test, which requires no testing equipment and provides quick results.

6.6.5 Hand moisture content test in the field

A simple way to check moisture content is to take a sample of the material and compact it in the hand. To determine if the soil contains the right amount of moisture is to squeeze the sample material into a fist-size ball:

- If it feels moist or runs out between the fingers, the soil is too wet for compaction. The moisture content is well beyond 105%.
- If, when the hand is opened again, the clay in the soil sticks in the fingers and the palm, the soil is once again too wet for compaction.
- If the material cannot be moulded into ball, the material contains too little moisture for compaction.
- If after being formed into a ball, (about 3cm diameter), the sample breaks neatly into large pieces when being squeezed between the thumb and forefinger, it has approximately the correct moisture content for compaction.

When handful of soil that was squeeze into a fist-size ball is then drop onto the ground from about 30cm:

- At optimum moisture content, the ball will break apart into a few even-sized fragments.
- If the soil is too wet, the ball will not break, (unless the soil sample is very sandy).
- If the soil is too dry, it will not form into a ball at all until you add some water.
- Gravel or mostly sandy soils do not react well to this test.

6.6.6 *Compaction*

The main reasons for compacting of road building materials such as soils, gravel and aggregate are:

- To increase the strength and load bearing capacity of the soil so that it can support the weight of traffic without being damaged.
- To reduce the permeability of the road, that is, to prevent water soaking into the road and making both the surface-course and sub-grade soft and easily damaged.

The effect of compaction is equally important for the road base as well as the surface layer. The increased strength of the base course allows for the passage of heavy loads without causing any deformation of the pavement.

The effect of compaction varies depending on the nature of the soil. Clayey materials behave differently from sandy materials or gravel. It is likely that the materials on site are a combination of clay, sand and gravel, with the result that each project needs a careful analysis of the soils and on this basis prescribe the necessary compaction method.

There are many different compaction methods and machines available, depending on the soil and on the class of road to be built. However, there are three methods to compact soil on construction of rural roads:

- Hand rammers, which are simply heavy flat plates, which are lifted and dropped onto the soil by hand. Hand rammers are used for small areas, such as backfill around culverts or patching side slopes of embankment. They are not suitable for large areas because it is very difficult to achieve the required level of compaction.
- Static rollers, which are heavy steel drum rollers, usually pulled by a tractor. They rely on the crushing force of their great weight to compact the soil. Their weight can be increased with stone or water ballast. They are most effective on soils with high gravel content, but less effective on clay soils, where they crush only a thin surface layer, without having any effect on the layers beneath, even in shallower fills. They do not give good bonding between successive fill layers.
- Vibratory rollers, are self-propelled by a small diesel engine, and work, by transmitting a ‘hammering’ force into the ground, with a series of rapid impacts. They can be a ‘pedestrian roller’, or a ‘ride-on roller’. The roller’s vibrations squeeze the soil particles into the tightest possible arrangement, filling the air and water voids and occupying a smaller space than previously. Vibratory rollers are very efficient and economical machines for compacting both cohesive and non-cohesive soils. They are most effective if the soil is slightly wetter than the optimum moisture content. The maximum thickness per layer of compaction should not be more than 15cm thick to achieve acceptable compaction.

Vibratory rollers weighing either 750kgs or 1400kgs are the most common compaction equipment used on labour-based road works. However, the 2000kgs vibratory ride-on rollers were found to be able to produce twice the output. Figure 14 shows a typical twin drum pedestrian vibratory roller and Figure 15 shows a self-propelled tandem ride-on roller used on labour-based project site for compaction.

Figure 14: *Double drum pedestrian roller*



Figure 15: *Self-propelled tandem roller*



Figure 16 and Figure 17 shows sheep-foot roller and larger single drum roller.

Figure 16: *Sheep-foot roller*



Figure 17: *Self-propelled single drum roller*



6.7 Cement

Concrete is a mixture of predetermined quantities of dry materials (cement, stone and sand) and water. By varying the quantities of these constituents in a mix the characteristics (e.g. strength) of the concrete product is affected. We can think of concrete as a 'man-made-rock' with great strength and long lasting properties, which can be shaped to build various structures.

Three ingredients of mixture that forms Concrete:

- i. Cement, which is an adhesive, composed principally of limestone and special clay,
- ii. Aggregate (coarse and fine), which is a well-graded mixture of gravel (coarse) and sand (fine), up to 40mm in diameter,
- iii. Water, which causes a chemical reaction to take place when it is added to a mixture of cement and aggregate, which hardens the mixture into what we call concrete.

Concrete is plastic when the three ingredients are first mixed and can be poured into almost any shape. After about one hour, it hardens to a strong mass possessing great durability, capable of carrying great loads and resistant to the effects of weather. However, its final strength depends on the way it is mixed, handled, compacted and cured.

The strength of concrete depends on:

- The proportions of cement, aggregate (gravel/sand) and water in the mix. Within certain limits, more of the cement 'glue' makes a stronger concrete. However, cement is very expensive and we therefore use no

Figure 18: *Cut-out of concrete block*

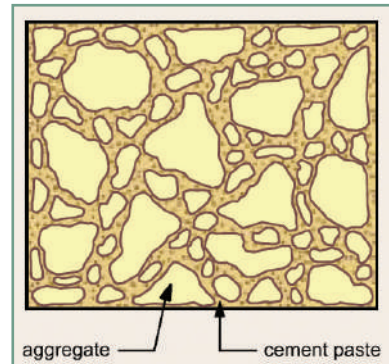

more than is necessary to produce the strength of concrete required for the structure. The proportions to be used therefore vary, depending on the purpose for which the concrete will be used.

- The use of clean, strong, well-graded aggregate. The aggregates form up to 80% of the concrete and so it is important that they are of the right quality. The bigger pieces of the aggregates form the ‘skeleton’ of the concrete and provide the compression strength. The smaller size particles of gravel and the sand fill the spaces between the bigger particles. The adhesive cement/water mix fills the smallest spaces between the aggregate particles and glues them all together into the finished concrete. The aggregates must not contain impurities, soil, twigs etc., as these will reduce the cement strength.
- The use of the correct volume of clean water, free of dissolved organic matter, or other impurities. Salt water is unsuitable.
- The compaction of the concrete after pouring, to remove all air voids.
- The curing of the concrete.
- The temperature at which the concrete has hardened.
- The type of cement used.

When the correct proportions of aggregate and cement are mixed with the right volume of water, the mixture will change from a plastic form into solid concrete over a period of about one hour. It is during this hour, before it starts to harden, that the plastic concrete is workable and must be poured into its final shape. However, it will take about 4 weeks (28 days) for the concrete to reach 95% of its full strength. This process by which the concrete becomes stronger with time is known as “curing”.

6.7.1 Storage of Cement

Cement is expensive and so must be stored and handled very carefully. Rain or even moisture from the air can enter torn bags and start the chemical reaction and ruin the cement. Cement must therefore be stored in a dry, well-ventilated area, on a raised platform to prevent ground moisture entering. Bags of cement should be stacked close together, but keep a clear space between the sacks and the walls. Lumps in cement are signs that the cement has been exposed to moisture. Stack the bags so that the first batch in can be the first out.

Figure 19: *Storage of cement on pallets raised above floor with proper ventilation*

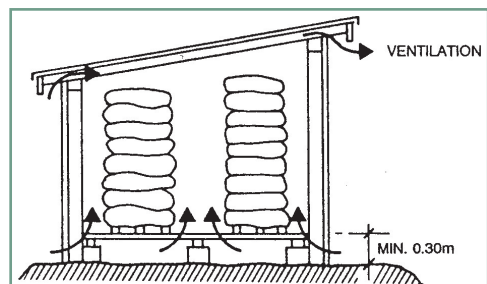

If it becomes necessary to store sacks of cement in the open, you should:

- Make a wooden platform about 300mm off the ground supported on bricks or timber.
- Cover bags with a tarpaulin or plastic sheeting. If more than one sheet is used, overlap them so that water runs off without wetting the bags.
- Weigh down the sheeting at the bottom and on top with reasonable weights that will not allow the wind to blow the sheeting away.

6.8 Aggregate for Concrete

Aggregates are usually obtained from riverbeds and the seashore. In some areas only crushed aggregates are available, but this is expensive and natural aggregates should always be used, where possible.

There are two separate aggregates used in making concrete, identified by the size of their particles:

- i. Fine aggregates (also called sand), which consist of particles between 0.5mm and 5mm.
- ii. Coarse aggregates (also called gravel, crush rock), which consist of particles between 5mm and 40mm. A soil technician can measure and confirm that an aggregate is well graded, that is, that there are equal quantities of all sizes from the smallest to the largest, but it is not possible to test every sample and so you must develop your judgement of what is a well-graded material. The technician can also test the aggregate strength. A simple test is to check if the gravel and stones will break down under compression, and this can be done by using a small hammer. Stones such as soft limestones break easily and are unsuitable.

Well-graded angular aggregate is ideal for use in concrete, as the angles of each piece of material 'interlock' between each other when placing concrete and so increase tensile strength. Well-graded round aggregates, such as river gravel, are also suitable for use in concrete as they mix easily and increase the workability (the ease with which it can be poured into shape) of the concrete. They also need less cement adhesive to coat them because of their smaller surface area. However, because of their rounded shape, they do not lock into the concrete the way that angular pieces of gravel do and so the strength of the concrete is lower when river gravel is used. Flat or saucer-shaped particles should not be used, as they require more of the cement/water mix to give good results.

Whatever aggregate is used, it is important that it is clean. Dirty aggregate containing various impurities, particularly clay and vegetable matter (sticks, twigs, leaves) which seriously weakens the concrete.

6.8.1 Storage of Aggregate

During transportation, storage and handling, aggregates must not be contaminated by impurities such as soil, clay, roots, leaves, fertilizer, sugar, salt, coal, etc. All of these can affect the quality of concrete.

The rules for good storage are:

- Do not place stockpiles under trees as leaves and seeds will contaminate the aggregates
- Rain water should drain away from stockpiles
- Aggregates should preferably be stockpiled on a concrete floor to prevent mixing with soil
- If a concrete floor is not used for the stockpile area, then the ground on which the aggregates are stored must be cleared of grass and roots and also compacted
- If different aggregate sizes are stored next to each other, retaining walls and partitions separating different materials must be high enough and strong enough to withstand the pressure of the aggregates.

6.9 Types of Concrete

There are three principal types of nominal concrete mix used in rural road works. These are determined by their mix proportions as described below.

Concrete mix 1:4:8: This is a meagre mix with low cement content. It is used for blinding the foundation excavations, for structures, where it acts as a clean working surface prior to placing mass or structural concrete. The mix proportions (cement : sand : stone) are 1 : 4 : 8.

Concrete mix 1:3:6: This is appropriate for gravity structures where reinforcing steel is not used. A large sized stone (up to 50mm) is therefore permitted. Larger stones would create mixing difficulties. The mix proportion is 1 : 3 : 6.

Concrete mix 1:2:4: This is concrete intended for use in reinforced structures and load bearing applications such as culvert rings. It is a higher strength of concrete and the maximum aggregate size is normally 20mm to allow the concrete to easily pass around steel reinforcement.

Concrete used in any structure shall be, apart from its grade designation, specified either as “Design Mix” or “Nominal Mix”.

Design mix concrete is that concrete for which the design of mix, i.e., the determination of the proportions of cement, aggregates and water is arrived at to have a target mean strength of concrete, is done.

Nominal mix concrete is that concrete for which the proportions of materials are specified.

For all terms of concrete, “Design Mix” shall be preferred to “Nominal Mix” because of better quality and it requires less quality of cement than the quality required for nominal mix for a specified grade.

6.10 Batching Concrete

The proportions of cement, sand, gravel aggregate and water used to produce concrete (called batching) can vary, depending on the different uses and required strength of the finished concrete. The mixed proportions are defined by the ratios by volume of the cement, sand and coarse aggregate components used in the mixture. The proportions of each ingredient are usually measured by volume for concrete structures on rural roads although they can also be measured by weight. The ratio of the first proportion given is the unit volume of cement. This is always given as just one portion. The second figure given in the ratio is the number of units of sand by volume, which can vary. The third figure in the ratio can also vary and is the number of units of coarse aggregates by volume. For example, the ratio 1 : 3 : 6 means: one volume of cement mixed with three volumes of sand and six volumes of coarse aggregate.

The process of measuring the three components, cement, sand and aggregate, in the correct amounts is called batching.

Batching should be done using a strong box, called a gauge box and are usually made of wood or steel.

A bag of cement is 0.035m^3 , so an ideal capacity for the gauge box could be $40\text{cm} \times 40\text{cm} \times 25\text{cm}$ corresponding to 0.04m^3 (Figure 20). The gauge box should be loose filled with the materials, for example, for a mix of 1 : 3 : 6, we use one bag of cement, 3 boxes of sand and 6 boxes of aggregate. The materials should be struck off level with the top of the gauge box with a straight edge. In some states the size of $12'' \times 12'' \times 15''$ is used.

Figure 20: Gauge box for batching concrete

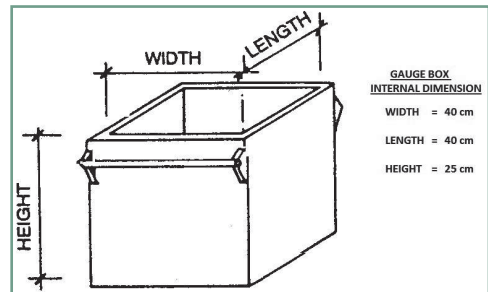

The material should never be measured out by shovel-loads, as no two such measurements will ever be the same. Table 8 gives three different mixes and the corresponding materials required to produce 1m^3 of finished concrete.



Table 8: *Materials required to produce 1m³ of concrete*

MIX RATIO	CEMENT / WATER	SAND	AGGREGATE
1 : 4 : 8 (lean concrete)	3 bags / 75 litres water	0.48m ³ (12 gauge boxes)	0.96m ³ (24 gauge boxes)
1 : 3 : 6 (mass concrete)	4 bags / 100 litres water	0.47m ³ (11.75 gauge boxes)	0.93m ³ (23.25 gauge boxes)
1 : 2 : 4 (dense concrete)	5.5 bags / 137 litres water	0.51m ³ (12.75 gauge boxes)	0.77m ³ (19.25 gauge boxes)

Table 9 provides other materials required for one bag of cement.

Table 9: *Materials required per 50kg bag of cement*

MIX RATIO	CEMENT / WATER	SAND	AGGREGATE	APPROXIMATE YIELD
1 : 4 : 8 (lean concrete)	1 bag / 22~27 litres water	0.16m ³ (4 gauge boxes)	0.32m ³ (8 gauge boxes)	0.32m ³
1 : 3 : 6 (mass concrete)	1 bag / 22~27 litres water	0.12m ³ (3 gauge boxes)	0.24m ³ (6 gauge boxes)	0.26m ³
1 : 2 : 4 (dense concrete)	1 bag / 22~27 litres water	0.08m ³ (2 gauge boxes)	0.16m ³ (4 gauge boxes)	0.19m ³

Note: Water content per bag of cement is between 22 to 27 litres depending upon the presence of moisture in the course and fine aggregate

Note that more than 1m³ of cement, sand and aggregate is needed to produce 1m³ of concrete. This is because there are many air voids, or spaces, in the loose materials, but very few voids in the finished concrete.

6.11 Concrete Production

The strength of concrete depends on the amount of water used, and more water means less strength. However, a minimum amount is needed to make the cement workable. Between 20 and 25 litres of water for each bag of cement is needed to produce workable and yet sufficiently strong concrete. Use the lower volume if the sand or gravel is already wet. So, for each bag of cement used in the batching process, the right volume of water should be carefully measured, using a container of known volume.

Too much water in the mix is one of the main causes of weakened concrete. Workers often use too much water, because it increases the workability and makes the concrete easier to mix and pour out after mixing. However, too much water allows segregation or separation of the materials so they are no longer evenly spread through the mixture, resulting in a reduction in strength of the concrete. The wetter the mix, the weaker will be the finished concrete.

Once the volumes have been accurately measured out in the gauge box, the components can be mixed together (dry mix) before the correct volume of water added to produce concrete. The quality of the finished concrete is only as good as the quality of the mixing. Concrete should be mixed as near as possible to the place where it will be used. It should be put in place before it starts to harden, which can occur within thirty minutes of being mixed in hot climate.

Machine Mixing: There are several types of machine mixers, but the tilting drum type is the most common used. The drum is conical in shape with internal vanes. It can be tilted to various positions to allow mixing and pouring. The drum is driven by a small petrol engine, which must be properly serviced and kept clean.

Figure 21: *Concrete mixer*



The batched coarse aggregate should be loaded first with a little water (this cleans the drum), followed by the sand, with the cement and remaining water last. This order will minimize cement loss because of any wind. The measured volume of water should be added gradually throughout the loading process. Do not overload the mixer, as this prevents the ingredients combining properly. The correct mixing time for a mixer up to 1m³ capacity is 1½ minutes. The drum must be cleaned thoroughly with fresh water after use.

Hand Mixing: It is common on small projects to mix the components by hand. However, there is a risk of poor concrete resulting from inadequate mixing. The materials should be mixed on a clean hard surface, such as a sheet of plywood boards. Do not mix on bare ground, as it will contaminate the concrete. Place the batched sand on the board and add the cement on top. Turn the heap over until it is a uniform colour. Then gradually add the batched gravel aggregate to the heap and turn the mixture until it is again a uniform colour. Form a hole in the centre of the heap and slowly add small amounts of water. Adding the water too quickly may wash some of the cement out of the mix. Carefully turn the dry material into the water with a 'cutting' action. Do not let the water escape. Continue to slowly add the water, turning the heap thoroughly, until the mix is uniform in colour and consistency.

6.11.1 *Transporting and Placing of Concrete*

The concrete should be transported in a wheelbarrow and poured into place. The haul routes for wheelbarrow hauling should be kept smooth to prevent segregation during transportation. If it is not possible to prevent segregation during transportation, the concrete must be remixed before it is placed. This problem is usually minimal with head-pans as the person carrying the pan acts as an efficient shock absorber. Careful handling is necessary to avoid

segregation, which occurs when the larger, heavier particles of aggregate sink to the bottom of the concrete mix, due to jolting and rough handling. The resulting uneven mix will produce concrete with weak, honeycomb patches. This is a particular risk when too much water is used in the mix.

Concrete should be poured as close as possible to its final position, certainly not from more than a height of 1m, as this will also cause segregation. In areas requiring deep concrete fill, it should be placed in horizontal layers, not in heaps. Concrete must be placed in layers of maximum depth of 300mm for hand compaction and 600mm for mechanical compaction. Each layer must be poured in one continuous operation before the

Figure 22: *Placing of concrete*

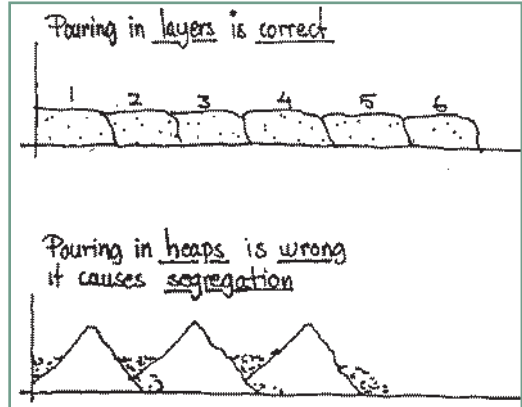

previous layer has hardened, to allow the two layers to bond together. Each layer should also be compacted before the next layer is placed. Concrete should not be placed during rain, as this may wash cement from the surface layer. Knocking of the shutter boards (formwork) will also be necessary for the air bubbles to get out and have a smooth finishing after removal of the shuttering. The shutters should also be greased with burnt oil to avoid the concrete bonding with the shuttering board. The formwork must be clean and all rubbish, scraps of timber or steel must be removed.

Air voids reduce the strength of concrete: 10% air voids in the finished concrete will reduce its final strength by 50%. The purpose of compacting concrete is to remove any air voids, to ensure maximum density and strength. Machine vibrators are used for

Figure 23: *Compaction of concrete by hand*

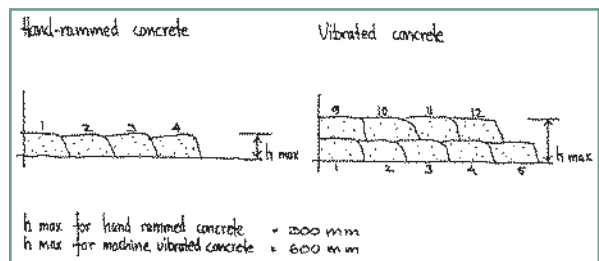

compaction on bigger projects, but good compaction can be achieved by hand, with care, on smaller sites.

A steel rod of about 2cm to 5cm diameter and 1.0m to 1.5m long is used for tamping the poured concrete. Hold the rod vertically and push it up and down to the full depth of the poured concrete. This has the effect of spreading the concrete into every space within the structure and removing any air bubbles. Do not tamp too hard or for too long a time, as this will result in segregation.

The final compacted concrete layer must be finished with a steel straightedge, called a screed board, to provide a smooth surface. The board should be slowly pushed forward with a sawing motion, pushing a small amount of concrete ahead of the board. Concrete should be shovelled up to or away from the front of the screed board, as required. Do not 'finish' where there is surface water. Cement should not be used to 'mop up' surface water, as this will cause surface cracking.

6.11.2 Curing Concrete

The weather has a big influence on the final strength of concrete. Concrete, which dries too quickly will not develop its full strength. The ideal conditions are to have a constant temperature of 20°C and a humidity of 80 ~ 90 % (humidity has to do with water in the atmosphere i.e. water carried in the wind or a material). Strength losses can be considerable if the temperature is above 30°C. Therefore in hotter than ideal climate it is very important that we try to keep the temperature of the concrete down as much as possible, to prevent it drying too quickly. Freshly poured concrete should never be exposed to sunshine.

The strength, wear resistance and stability of concrete all improve with time, as long as conditions are favourable. This improvement is known as curing and is very rapid in the early stages, but continues for a long time. The curing process that occurs within the first 28 days is very important for the final strength of the concrete.

Two conditions are required for good curing:

- **The presence of moisture:** Evaporation of water from newly placed concrete can cause the chemical process to stop. It may also cause the concrete to shrink. It is therefore important to keep the concrete – including the edges of slabs – moist during this 28-day period. The simplest method is to cover the concrete with moisture retaining materials, such as plastic sheet or moistened sack (see Figure 24). If these are not available, a covering of wet sand or soil about 50mm thick will do. Continuous water sprinkling is also an excellent method therefore a labourer should be assigned just for curing of the concrete work. Shading the curing concrete completely from direct sunlight is also

Figure 24: *Curing of concrete with wet gunny sacking*



very beneficial. On flat surfaces such as culvert aprons, a water-filled earth or clay dam can be constructed around the concrete. This method, called ponding, retains the moisture during curing (see Figure 25). Concrete cured in the air without being kept moist may only have two thirds of the strength of concrete cured moist.

Figure 25: *Creating a water pond for curing*



- **An even temperature:** Exposure to hot sun will heat the concrete and speed up the evaporation of moisture. A large variation between day and night temperatures will cause erratic curing conditions. It is therefore important to try to maintain an even temperature in the curing concrete. Ponding, as described above, also helps maintain an even temperature while the concrete is curing. It can also be shaded from the sun with plastic sheet, tarpaulins or banana leaves etc.

6.12 Reinforcing Concrete

As explained earlier in this module, the strength of concrete must be reinforced where it will be subject to tensile (pulling) loads, such as in the deck slab of a box culvert. This is done by combining steel rods or mesh into the concrete, so as to take best advantage of the characteristics of each material. The steel mesh is securely fastened in the area requiring strengthening before the concrete is poured. It must be laid so that it is enclosed by at least 25mm of concrete. The poured concrete bonds with the mesh as it cures and the two materials act as though they are one when a load is applied, with the steel providing the necessary tensile strength. The resulting material is known as reinforced concrete.

Steel should be stored away from workshops where oil and greases are used. Any oil or grease on the steel should be scraped or rubbed off and the steel should then be washed down with a strong detergent. Unless the placement of the steel reinforcement is done correctly according to the drawing the reinforced concrete will not achieve its desired strength.

The important points that require checking and supervision for reinforcement works are:

- All reinforcing bars and mesh must be fixed in the positions shown on the engineer's drawings.

- The bars must be properly tied together with binding wire and the long ends of the wires must be clipped off.
- Sufficient spacers must be securely fixed to make sure that the correct concrete cover to the reinforcement is obtained in the whole structure. Spacers shall be made of well cured mortar. Wooden blocks, pieces of stone or brick must not be used for spacers.
- Steel must not be trampled or pushed out of position by the concreting gang or the placing equipment.

6.13 Testing Concrete

The main quality of good concrete is a high compressive strength, measured in Mega-Pascal (MPa). There are several laboratory methods of testing concrete, which will be carried out by the soils technician. You will be required to prepare concrete samples in special moulds. These will be cured for a specified time, usually 28 days, and then tested in the laboratory by crushing until they break.

The Slump Test

However, there is one useful simple test, which you can do to check the quality of your concrete. This is known as slump test.

Equipment for the slump test includes a standard slump cone (300mm high, 200mm diameter at the bottom and 100mm diameter at the top), a 600mm by 15mm bullet pointed steel rod and a ruler. All equipment must be clean. The inside of the slump cone must be moistened before starting the test.

To make the test, the cone is placed large end down on a level surface and held down firmly by the footrests. It is then filled with concrete from the sample, in three equal layers. Each layer should be tamped 25 times with the tamping rod, which must penetrate to the layer beneath (see Figure 26).

Figure 26: *Tampering with rod in layers*



The slump test checks the consistency (workability) of concrete and is a simple way of ensuring that each mix of concrete is of consistent quality. Several tests should be carried out each day to check that consistency is being maintained. A consistent slump measurement means that the concrete is “under control”. If the test results vary, it means that something else has varied either the amount of water added or the ratio of materials in the mix. This must be avoided because, as we have learned, variation in water content, the ratio of the mix or the aggregate grading and particle shape will also affect the finished concrete strength.



After the top layer has been compacted, the surface of the concrete should be struck off level with the top of the cone and any surplus concrete removed from around the base (Figure 27). The slump cone should then be lifted off carefully but firmly, so that the concrete is free-standing. When it is unsupported it will slump, or sink, to some lower level. If a specimen shears (collapses sideways), the test should be repeated. If it shears again, the slump should be measured and recorded, with an appropriate note (Figure 28).

Figure 27: *Struck off level with top of cone*



Figure 28: *Measuring difference in height after removal of cone*



To measure the slump, place the cone narrow end down alongside the concrete and measure to the nearest 10mm the amount by which the concrete has slumped, i.e. the difference in height between the top of the cone and the top of the cement.

The measured slump should be a minimum of 25mm and a maximum of 125mm. The most important figure is the maximum of 125mm. Any slump greater than this means that there is too much water in the mix and the strength of the resulting concrete will definitely be reduced. There will also be a high risk of segregation. (refer to Table 10).

Table 10: *Interpretation of results*

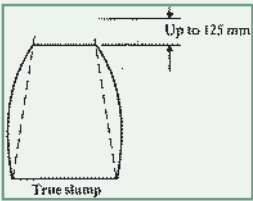
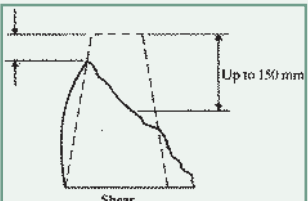
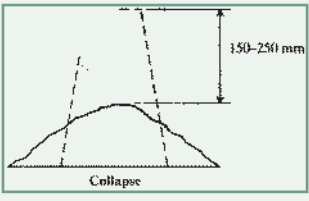
TRUE SLUMP	SHEAR SLUMP	COLLAPSED SLUMP
 <p style="text-align: center;">True slump</p>	 <p style="text-align: center;">Shear</p>	 <p style="text-align: center;">Collapse</p>
<p>In a true slump the concrete simply subsides, keeping more or less to-shape indicating good concrete.</p>	<p>In a shear slump the top portion of the concrete shears off and slips sideways.</p>	<p>In a collapse slump the concrete collapses completely due to excess water in the mix.</p>

Incidence of Poor Quality Concrete

Some of the common problems identified which eventually results in poor quality concrete are:

- No attempt was being made to properly batch concrete.
- Dry ingredients were added to the mixer by the shovel-full or headpan load according to the whim of the concrete foreman.
- Water was added until the mixture was judged sufficiently wet to achieve easy compaction, usually to give a thin soupy consistency.

This inability to control the water content meant that there was no effective control of the strength of the concrete being produced. Typical concrete strengths, as measured by Schmidt Hammer, were 10N/mm² to 15N/mm². Many tests indicated that the concrete strength was too low for determination by Schmidt Hammer, < 10 N/mm².

Prescribed volumetric mixes were generally specified, 1:3:6 and 1:2:4 being the most common. In addition, a typical specification for structural concrete would include minimum cement content and a maximum Water/Cement ratio. These Water/Cement ratio and cement content requirements were routinely ignored and in practice only the most diligent of contractors would batch the dry ingredients by volume and add just sufficient water to achieve a workable mix.

The resulting concrete was low strength and usually riddled with honeycombing due to severe grout loss through formwork. Cosmetic rendering, or 'plastering', of concrete with a sand/cement mix to hide defects after formwork removal, though not a payment item and totally against the specifications, was the norm. Such 'plastering' is not structural and usually cracks and peels-off over time. It is not an acceptable form of repair. However, rather than putting our efforts into the proper repair of honeycombed concrete, it was decided to focus on the elimination of its occurrence.

Other contributory factors to the poor quality concrete encountered were:

1. Shoddy workmanship including:
 - poor quality formwork
 - use of sub-standard materials
 - inferior construction techniques
2. Inadequate supervision, including:
 - Contractors working without supervision
 - inadequately qualified, experienced or trained supervisors, especially junior site staff
 - absence of effective quality control measures
3. Inferior site practices including:
 - pre-mixing large volumes of dry constituents by hand and subsequent wet mixing of smaller sub portions leading to variable quality (although quality was universally poor owing to high water content).

- lack of appreciation of basic concrete technology particularly compaction and curing.

Attributes of Good Quality Concrete

Having identified some of the problems encountered the next stage was to define what were the desirable characteristics of good quality concrete that needed to be achieved. These desirable characteristics include:

- Having the desired consistence (slump) when plastic.
- Conforming to desired strength requirements.
- Hard, dense and durable when cured.
- Production of each batch to a uniform quality.

Only one type of cement (OPC produced from grinding imported clinker) is readily available in Ghana. There are no local industries that produce cementitious extenders such as fly ash and ground granulated blast furnace slag as by-products and the use of admixtures and additives by smaller contractors is uncommon. A simple approach to basic concrete mix design, employing only the four basic constituents of cement, water, stone and sand, was clearly warranted.

A characteristic strength for concrete is always assumed as part of the structural design process. It was decided to adopt an approach to concrete mix design that would achieve the desired consistence (slump) when plastic and the strength determined during structural design.

6.14 Bitumen

Bitumen is the most common road construction material. Obtained in natural form or by fractional distillation of crude oil. Used as a binder of stone aggregate in several types of road construction.

Bitumen 80/100: This is the softest of all grades available in India. Suitable for low volume roads and is widely used in the country.

Bitumen 60/70: This grade is harder than 80/100 and can withstand higher traffic loads. Used mainly in construction of National Highways and State Highways.

Bitumen 30/40: This is the hardest of all the grades and can withstand very heavy traffic loads. Bitumen 30/40 is used in specialized applications like airport runways and also in very heavy traffic volume roads in coastal cities in the country.

Cutback: Free flowing liquid at normal temperatures and is obtained by fluxing bitumen with suitable solvents. The viscosity of bitumen is reduced substantially by adding kerosene or any other solvent. Cutback has been used in tack coat applications

Modified Bitumen: Modified Bitumen are bitumen with additives. These additives help in further enhancing the properties of bituminous pavements. Pavements constructed with Modified Bitumen last longer which automatically translates into reduced overlays. Pavements constructed with Modified Bitumen can be economical if the overall lifecycle cost of the pavement is taken into consideration.

Bitumen Emulsion: Bitumen emulsion is a free flowing liquid at ambient temperatures. It is chocolate brown free flowing liquid at room temperature. The bitumen content in the emulsion is around 60% and the remaining is water. When the emulsion is applied on the road it breaks down resulting in release of water and the mix starts to set. Three types of bituminous emulsions are available, which are Rapid setting (RS), Medium setting (MS), and Slow setting (SC). Bitumen emulsions are ideal binders for hill road construction. Where heating of bitumen or aggregates are difficult. Rapid setting emulsions are used for surface dressing work. Medium setting emulsions are preferred for premix jobs and patch repairs work. Slow setting emulsions are preferred in rainy season.

Bituminous Primers: In bituminous primer the distillate is absorbed by the road surface on which it is spread. The absorption therefore depends on the porosity of the surface. Bitumen primers are useful on the stabilized surfaces and water bound macadam base courses. Bituminous primers are generally prepared on road sites by mixing penetration bitumen with petroleum distillate.

Table 11: *Viscosity Grade of Bitumen*

Grade	Min. absolute viscosity Poise at 60° C	Approximate equivalent penetration grade
VG10	800	80/100
VG20	1600	-
VG30	2400	60-70
VG40	3200	30/40 & 40/50

6.14.1 Requirements of Bitumen

The bitumen:

- Should not be highly temperature susceptible. During the hottest weather the mix should not become too soft or unstable, and during cold weather the mix should not become too brittle causing cracks.
- The viscosity of the bitumen at the time of mixing and compaction should be adequate. This can be achieved by use of cutbacks or emulsions of suitable grades or by heating the bitumen and aggregates prior to mixing.
- There should be adequate amity and adhesion between the bitumen and aggregates used in the mix.



This training module is produced through a collaborative effort between the International Labour Organization and the National Rural Road Development Agency under the technical assistance component of the World Bank supported Rural Roads Project-II of Pradhan Mantri Gram Sadak Yojana Project (PMGSY).



INTERNATIONAL LABOUR ORGANIZATION
ILO DWT for South Asia and Country Office for India
India Habitat Centre
Core 4B, 3rd Floor, Lodhi Road
New Delhi-110 003, INDIA



NATIONAL RURAL ROADS DEVELOPMENT AGENCY
Ministry of Rural Development, Government of India
5th Floor, 15-NBCC Tower
Bhikaji Cama Place
New Delhi-110 066, INDIA